

4355 / 28 Cassandra 1

# 4355 / 28 Cassandra 1

4368

4140

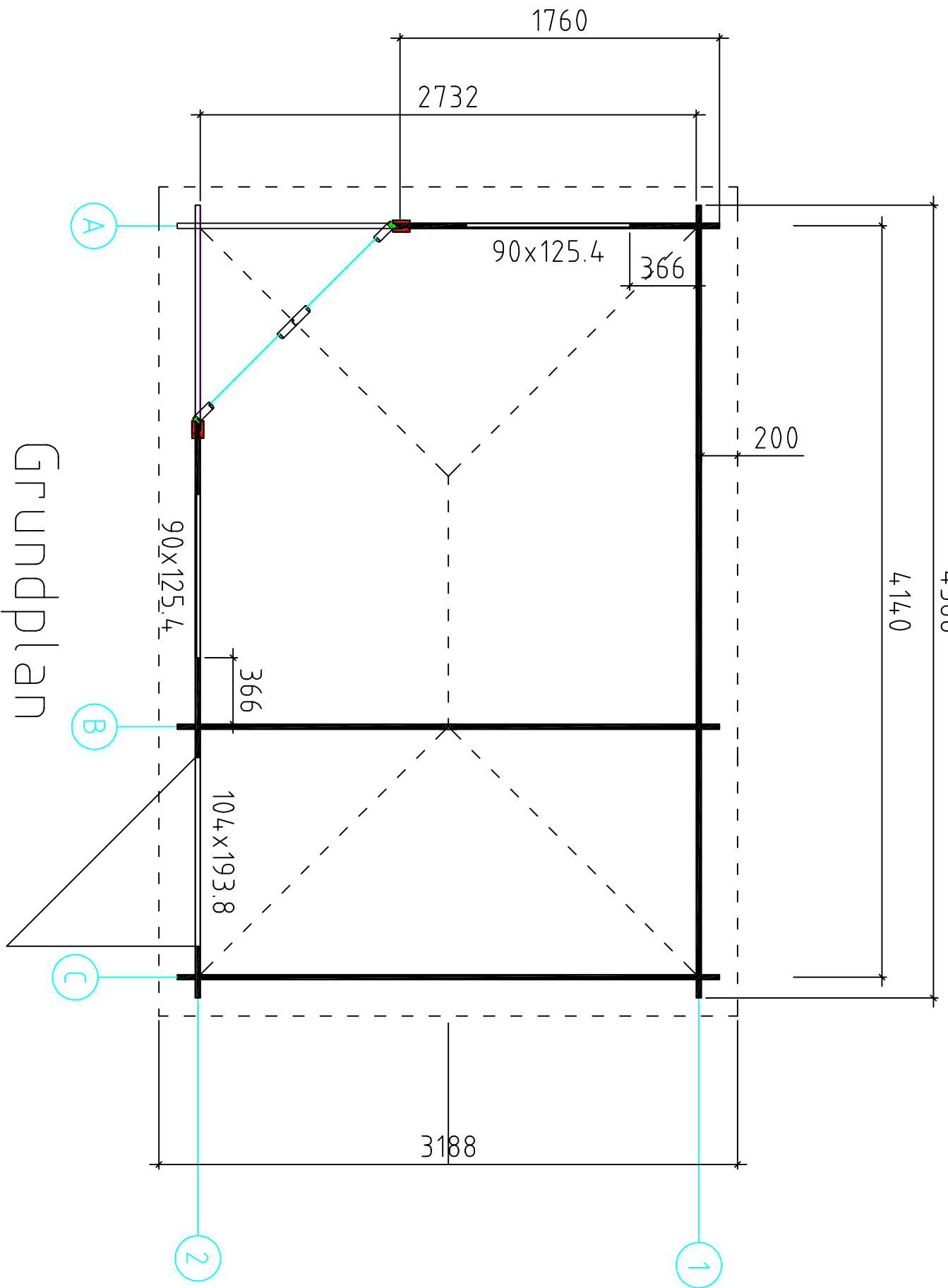

Grundplan

4355 / 28 Cassandra 1

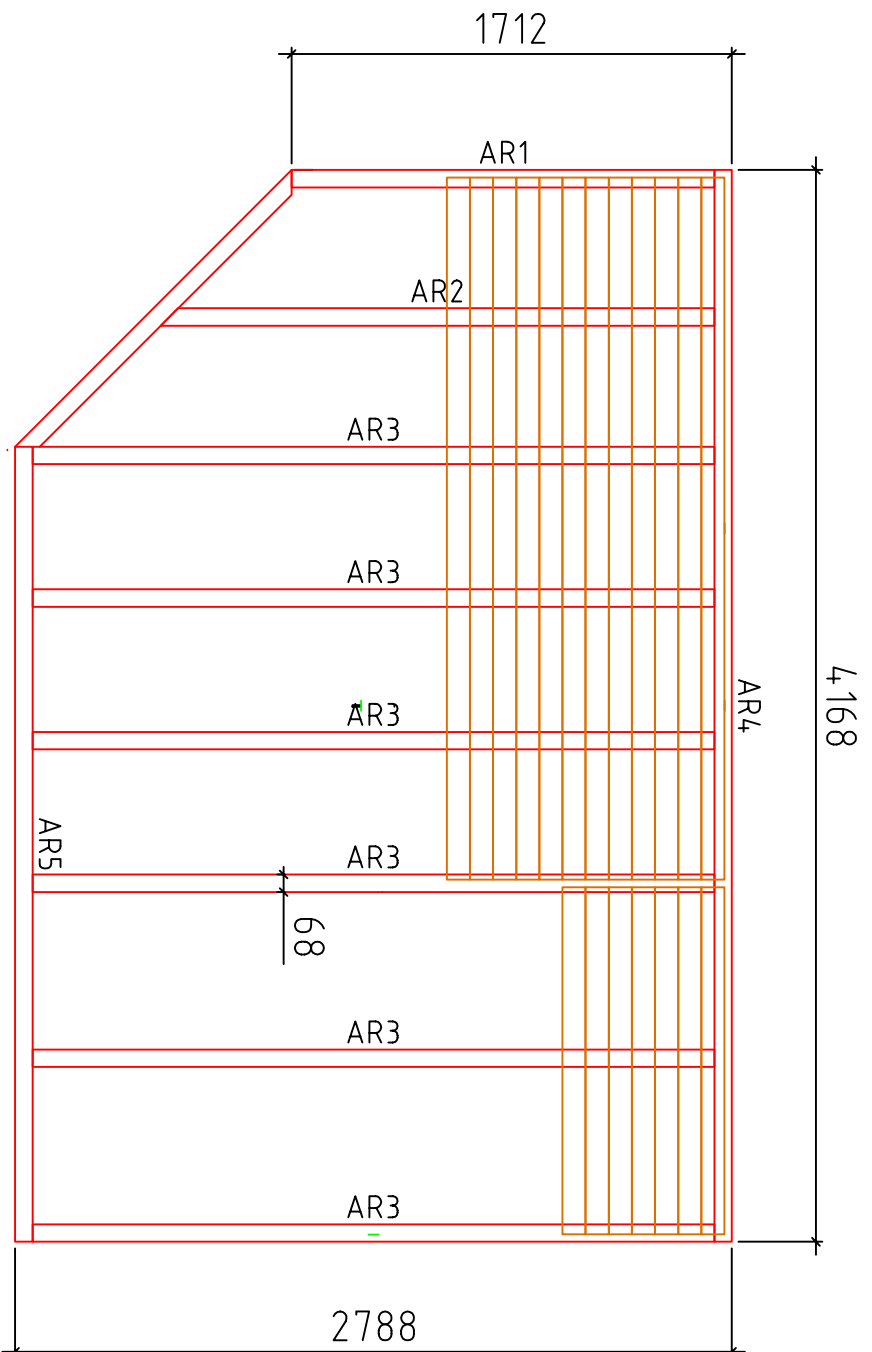

Fundament 68x44 (AR)

# 4355 / 28 Cassandra 1

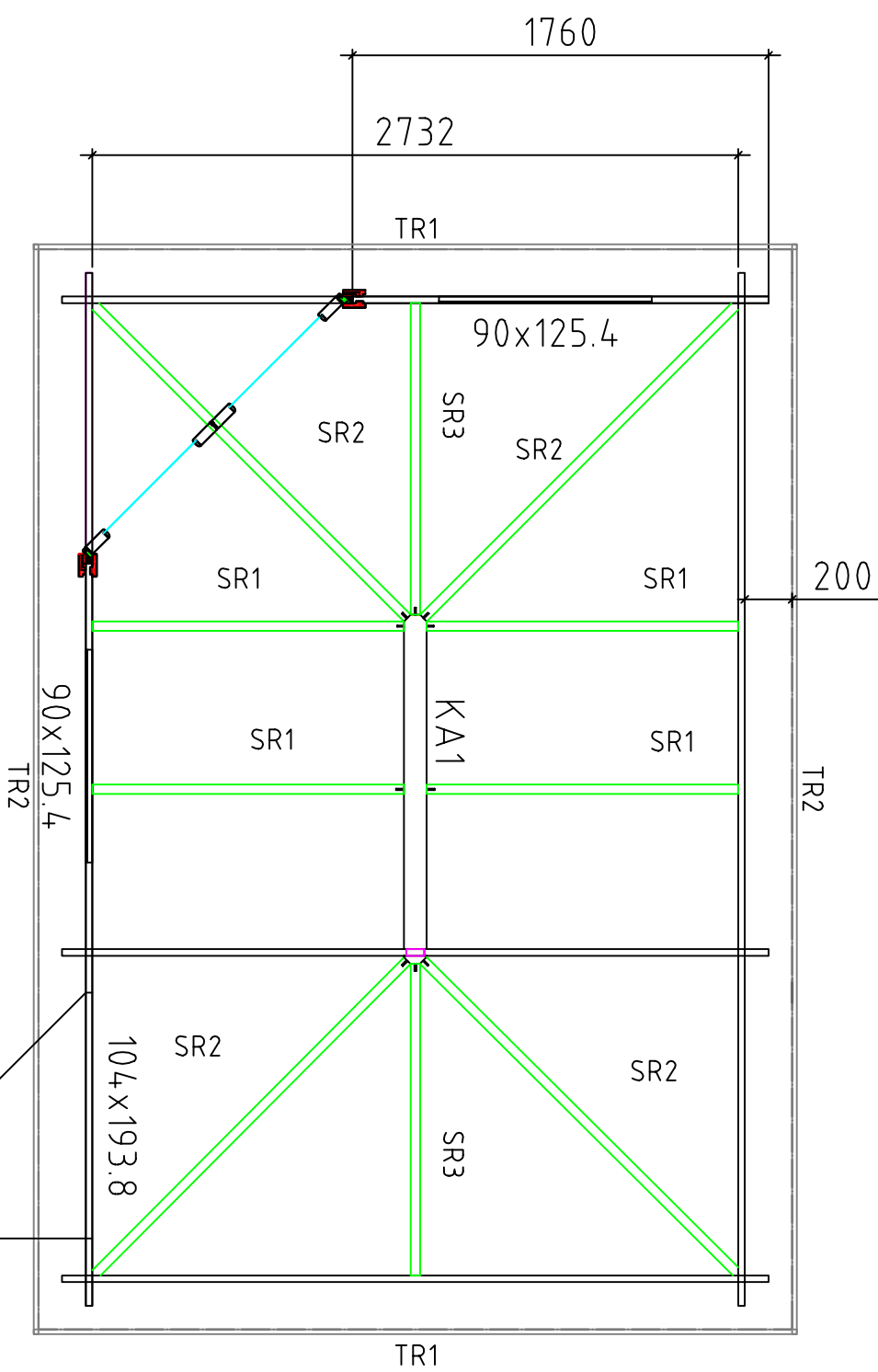

Dachbalken 40x58 (SR)

# 4 355 / 28 Cassandra 1

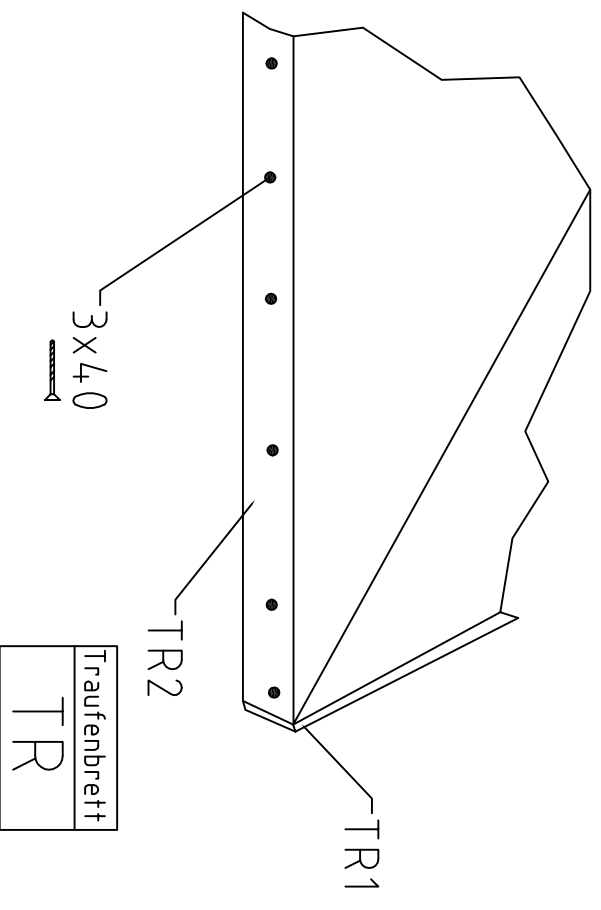
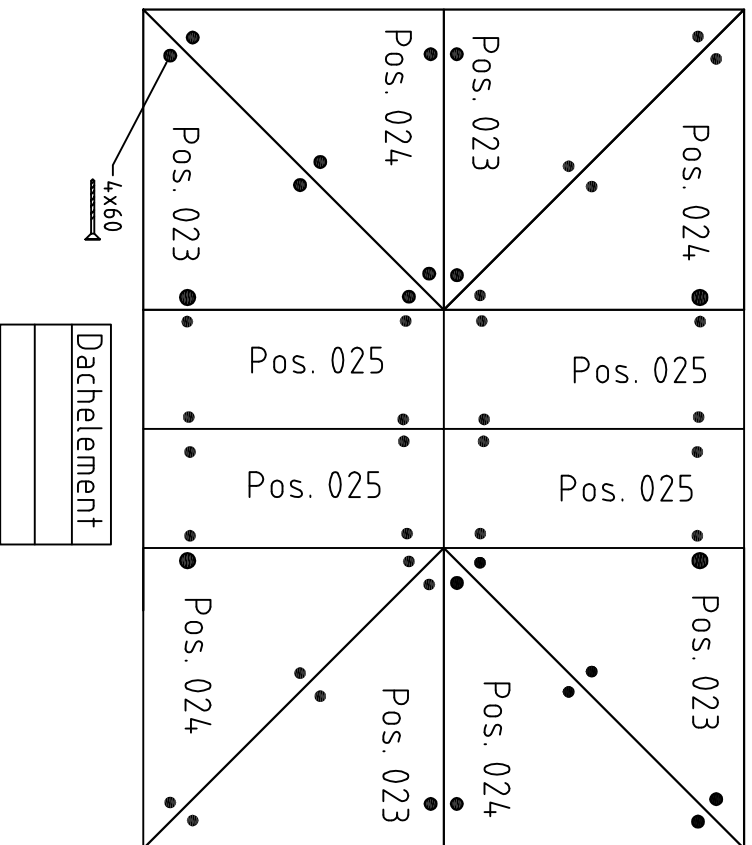

# 4355 / 28 Cassandra 1

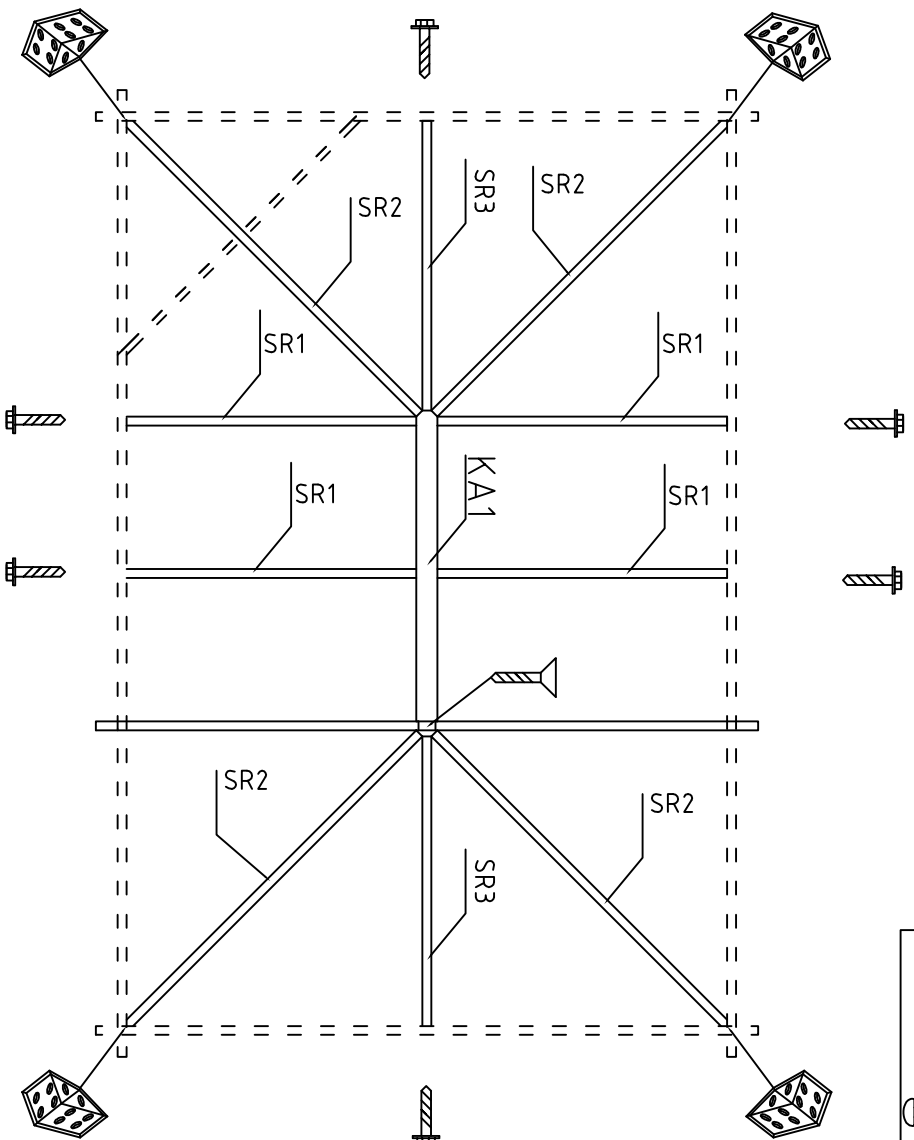
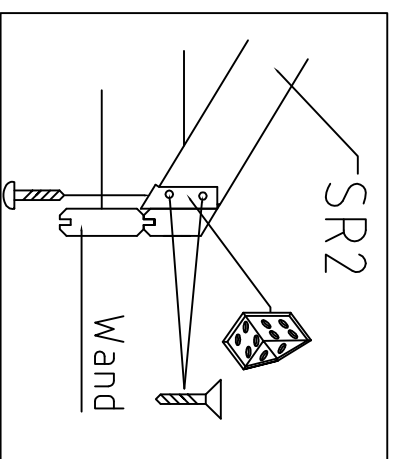

Dachbalken 40x58 (SR1)  
Montage

# 4355 / 28 Cassandra 1

KA1

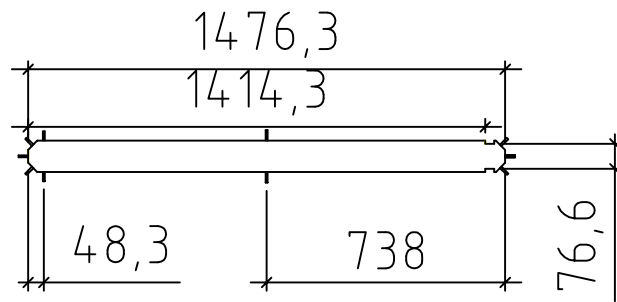

SR2

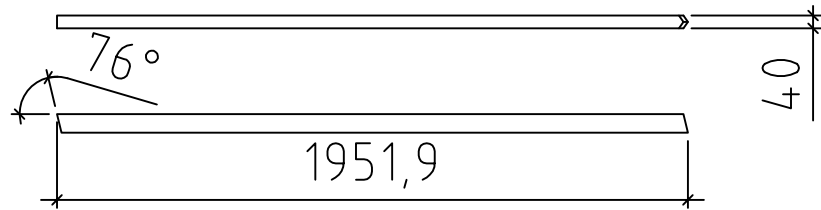

SR1

SR3

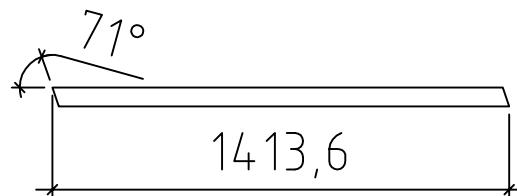

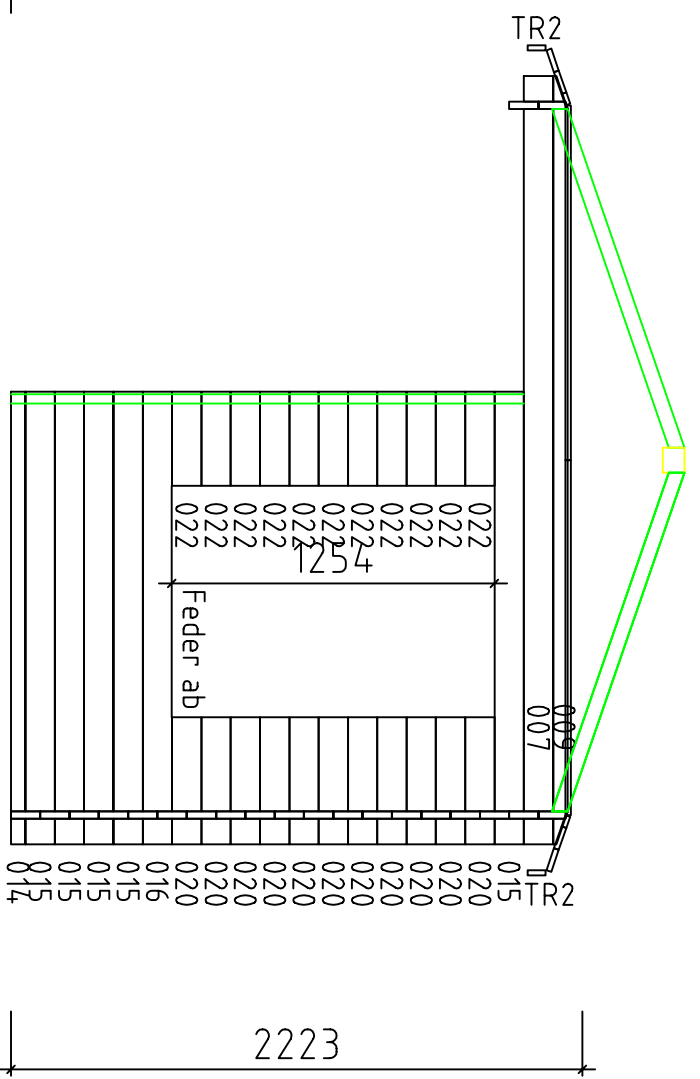

Wand A ↗

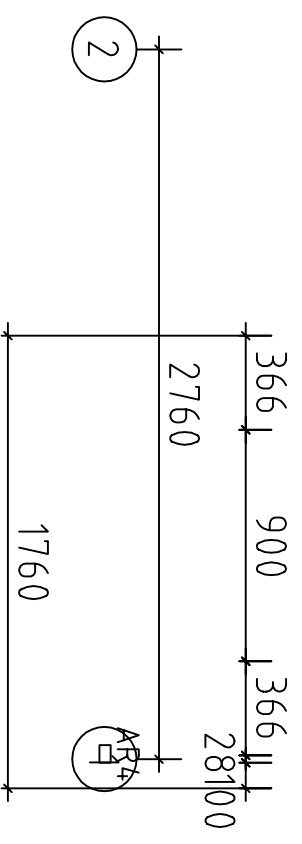

4355 / 28 Cassandra 1





Wand C ↗

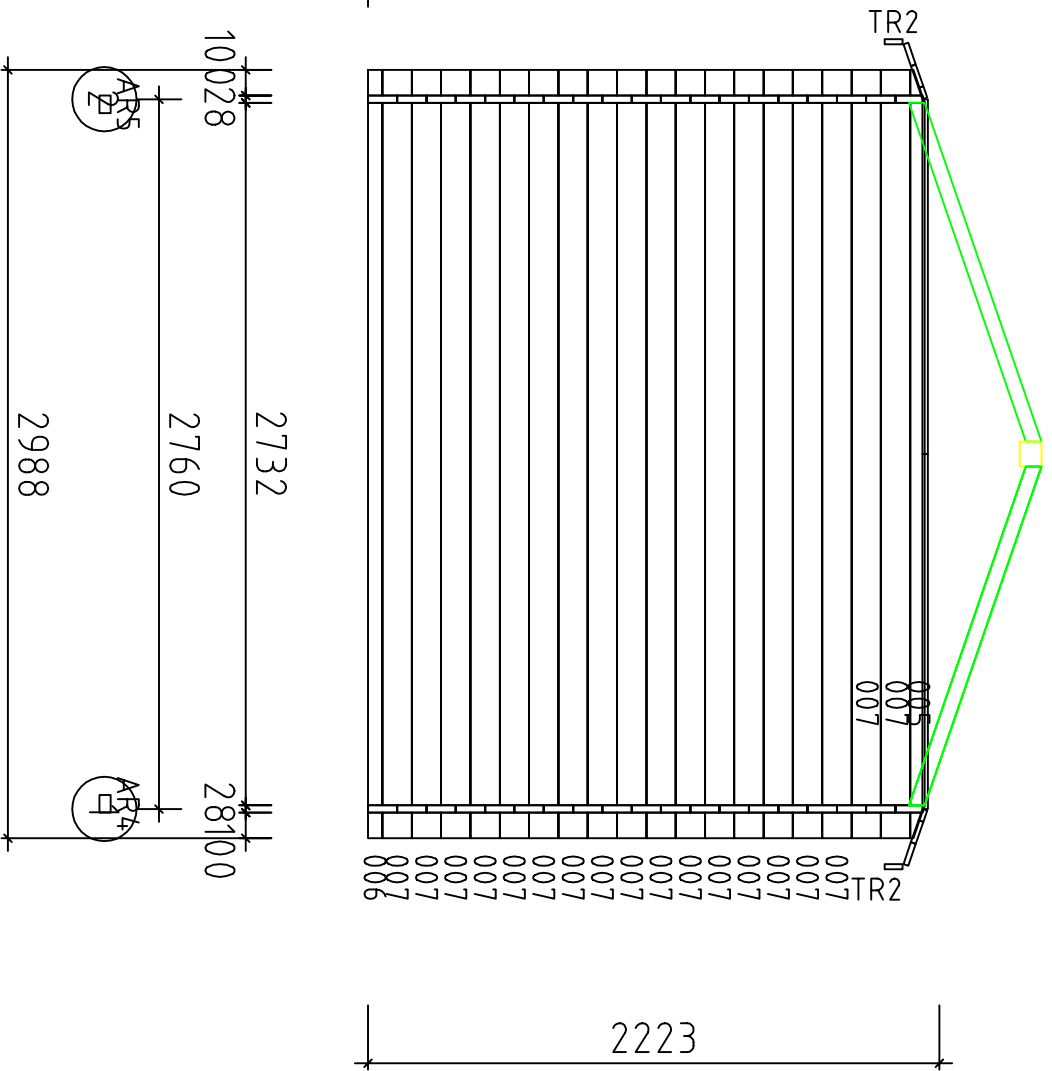

4355 / 28 Cassandra 1





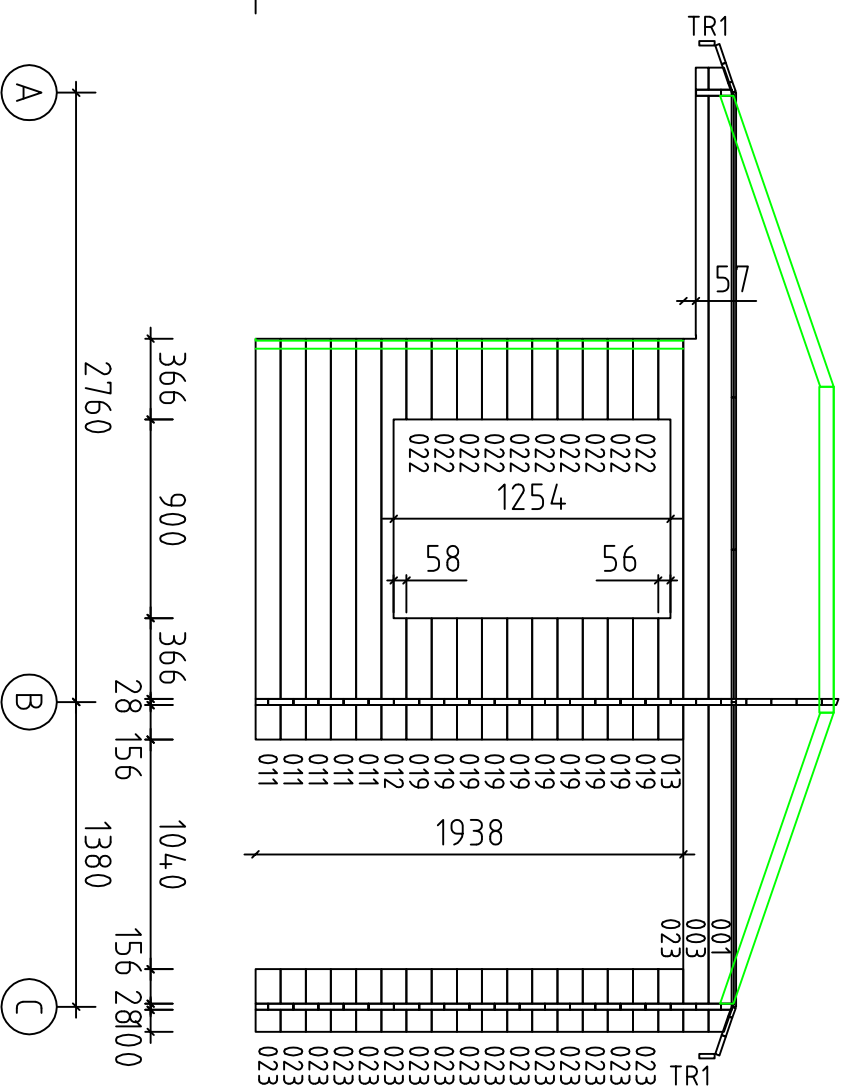



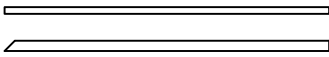

Wand 2 ↗

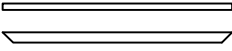
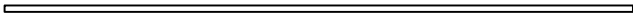

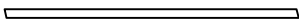

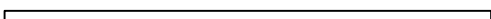
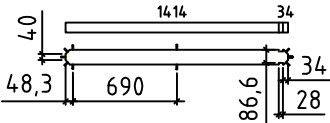

4355 / 28 Cassandra 1

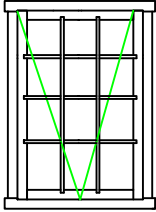
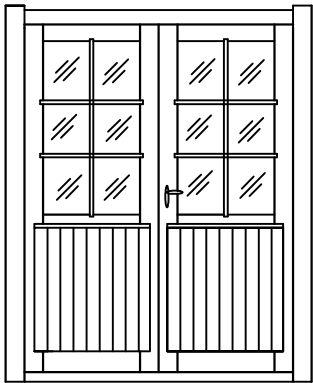
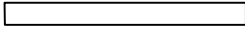
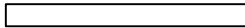
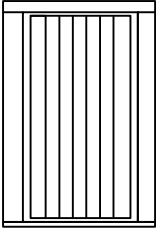
Pos	4355 /28 Cassandra 1		ST	F (mm)	L (mm)
001			1	28x114	4368
002			1	28x114	4368
003			1	28x114	4368
004			18	28x114	4368
005			1	28x57	2988
006			2	28x57	2988
007			37	28x114	2988
008			1	28x114	2988
009			1	28x57	2988
010			1	28x114	2401
011		Sooned kahelt poolt 8xx35mm	5	28x114	1816
012		Sooned kahelt poolt 8xx35mm	1	28x114	1816
013		Sooned kahelt poolt 8xx35mm	1	28x114	1816
014		Sooned kahelt poolt 8xx35mm	1	28x57	1760
015		Sooned kahelt poolt 8xx35mm	5	28x114	1760
016		Sooned kahelt poolt 8xx35mm	1	28x114	1760
017			1	28x114	1739
018			1	28x114	1077
019			10	28x114	550
020			11	28x114	494
021			1	28x71	414
022		Sooned kahelt poolt 8xx35mm	21	28x114	366
023			17	28x114	284

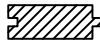
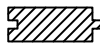
Pos	4355 /28 Cassandra 1	ST	F (mm)	L (mm)
AR3	 Fundamentbalken	6	68x44	2652
AR2	 Fundamentbalken	1	68x44	2154
AR1	 Fundamentbalken	1	68x44	1644
AR6	 Fundamentbalken	1	68x44	1522
AR4	 Fundamentbalken	1	68x44	4168
AR5	 Fundamentbalken	1	68x44	3092
SR2	 Dachbalken	4	40x58	1952
SR3	 Dachbalken	2	40x58	1414
SR1	 Dachbalken	4	40x58	1414
TR2	 Traufenbrett	2	20x70	4608
TR1	 Traufenbrett	2	20x70	3228
KA1	 Firstbalken	1	96.6x65	1476
Kood	Materjal	File	trükk.dwg	Leht 2/4





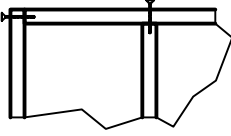
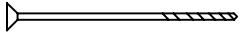
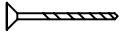

Pos	4355 /28 Cassandra 1	ST	F (mm)	L (mm)				
F1	Fenster 900x1254 A Klapp  1xGlas 727x1062 1tk	2						
U155S	TÜR 1499x1970 A Roostevaba plekk 28x34; L=1498 mm  <table border="1" data-bbox="743 788 1120 878"> <tr> <td>1xGlas</td> <td>551x1062 2tk</td> </tr> <tr> <td></td> <td>kotike 1 kmpl.</td> </tr> </table>	1xGlas	551x1062 2tk		kotike 1 kmpl.	1		
1xGlas	551x1062 2tk							
	kotike 1 kmpl.							
100	Abdeckleiste 	1	20x50	1580				
101	Abdeckleiste 	1	20x90	1499				
023	TÜR 1938x1040 A 	1R						

Pos	4355 /28 Cassandra 1			ST	F (mm)	L (mm)
0203-1	Fussbodenbretter			31	90x20	2730
0203-2	Fussbodenbretter			31	90x20	1350
Pos						
022	Giebelelement Frontelement Gevelement			1	1060x1060	
023	Dachelement Roofelement Dakelement			4	1595x1685	
024	Dachelement Roofelement Dakelement			4	1595x1685	
025	Dachelement Roofelement Dakelement			4	690x1695	

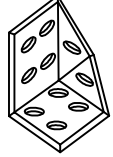
Montagematerial

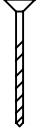
Fundament		Torx	Schrauben 6x130		40		
Fussboden		Torx	Schrauben 3,5x50		300		

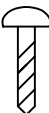
Dachbalken,  
Firstbalken  
Traufenbretter  
Dachschilden

3x40	4x80	5x16	5x16		4x60
					
46 st.	6 st.	16 st.	8 st.	4 st.	96 st.